

# Предпазно изпускателен вентил JSAV

За природен газ, градски газ, LPG, биогаз, въздух

## Инструкция за монтаж и експлоатация



**ВНИМАНИЕ!** Монтаж, настройка и обслужване се извършват само от правоспособен персонал!



### Декларация за съответствие

Ние като производител декларираме, че продуктите JSAV 25-40, с идентификационен номер 0085AS0202 и JSAV 50-100 с идентификационен номер 0085AR0246, съответстват на директива: - 90/396/ЕЕС съгласно DIN 3381.

Същите изцяло съответстват на изпитаните мостри от оторизирани лаборатории 0063 и 0085.

Цялостната защита на качеството се гарантира от оторизираната Система по мениджмънт, според DIN EN ISO 9001, съгласно анекс II, параграф 3 на Директива 90/396/ЕЕС.

**G. Kromschroder AG**  
Osnabrück

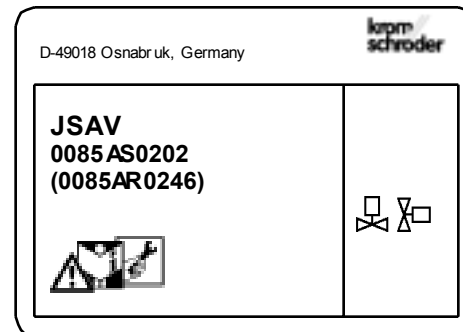

### Монтаж

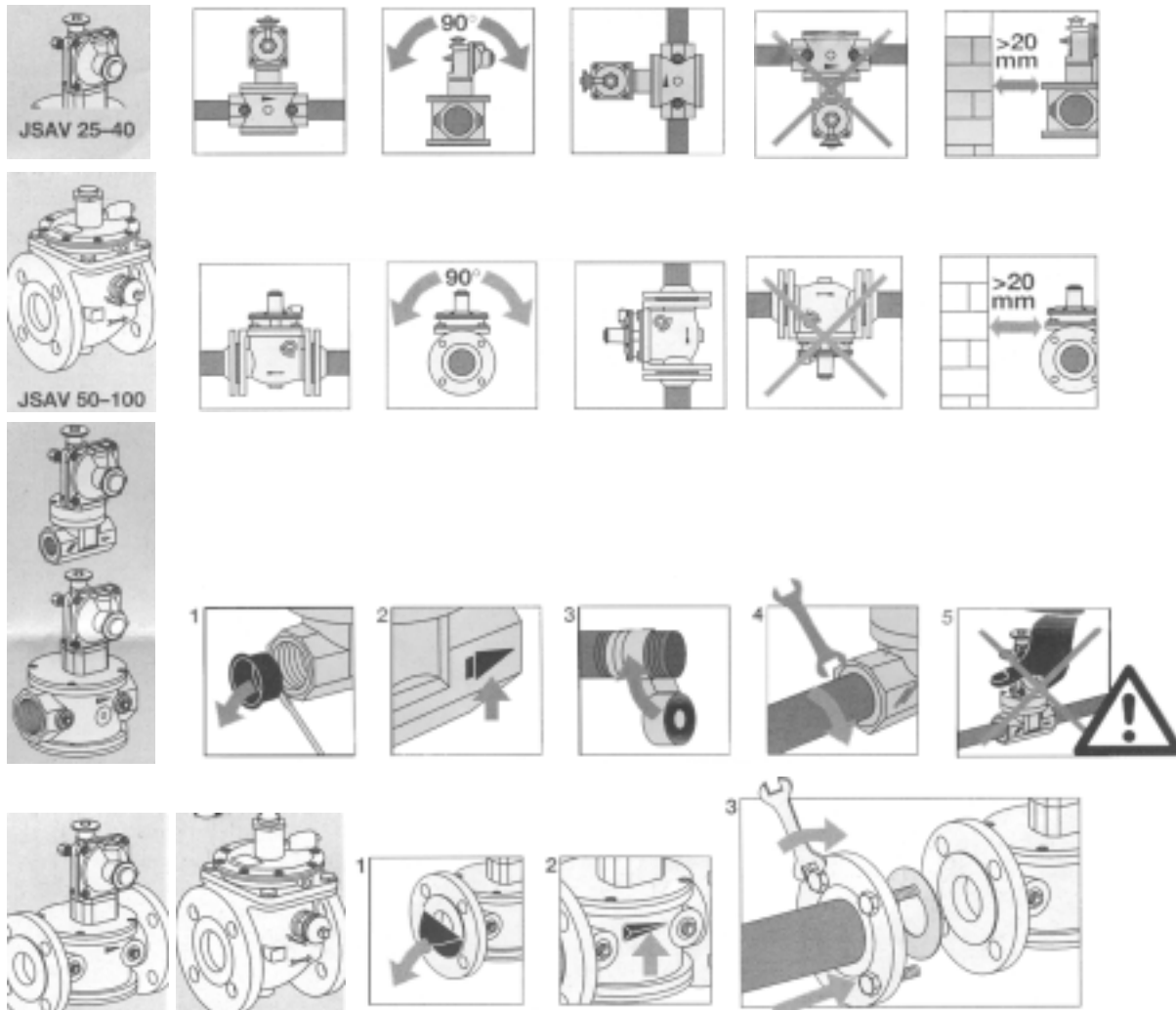

## Присъединяване на импулсната линия

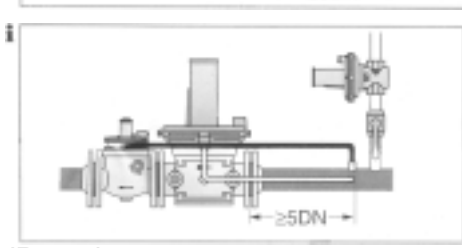
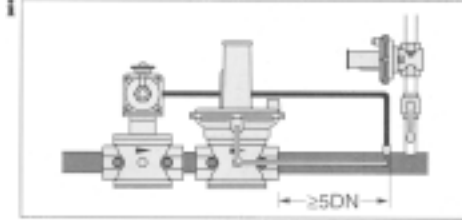
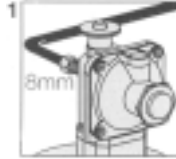

## Деблокиране (Reset)

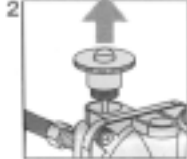
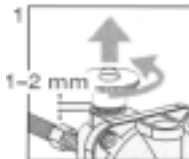

Задръжете (изравнете налягането) докато бутона се освободи.

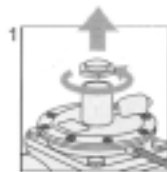
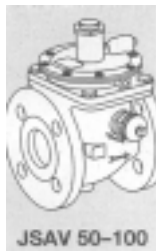

Притиснете до упор, задръжете до изравняване на налягането и завъртете рамото. След изщракване(заклучване) уредът е деблокиран.

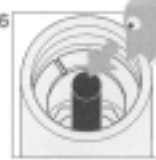
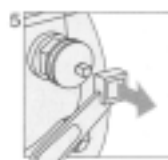

## Проверка на плътност

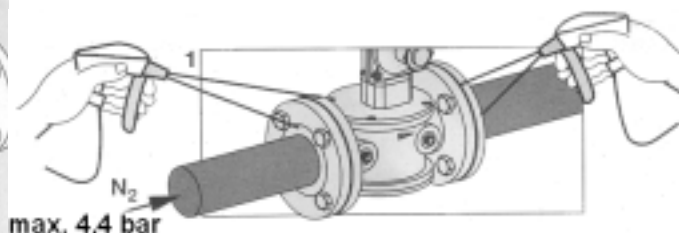
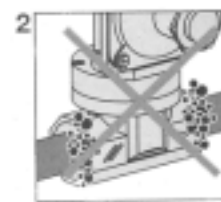
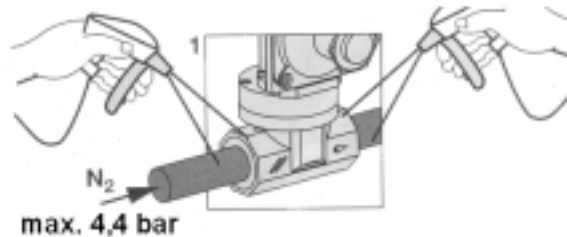



max. 550 mbar

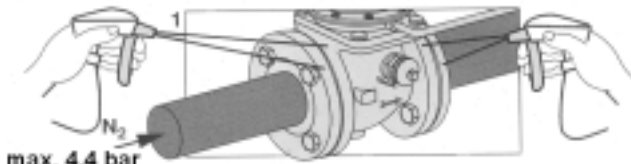
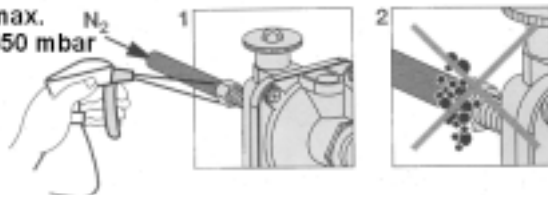

max. 4,4 bar



max 550 mbar

### Настройка на налягането на сработване

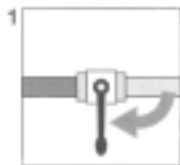

2 Затворете спирателният кран преди уреда.

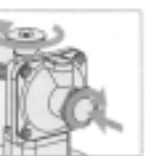
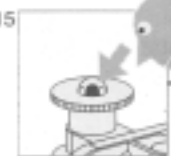
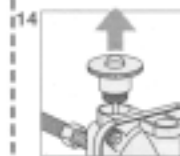
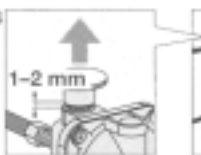
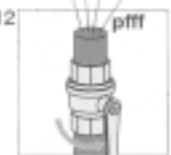
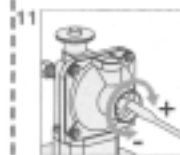
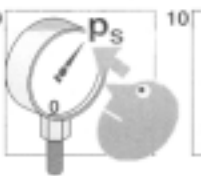
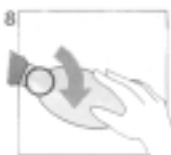
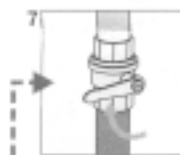
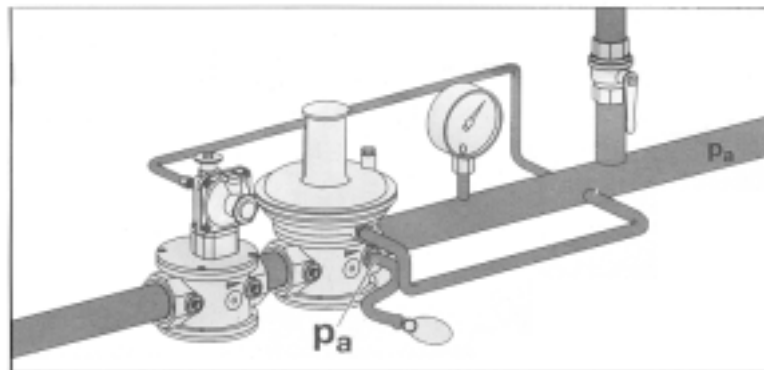
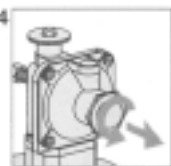
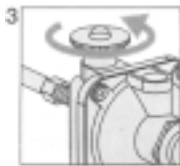

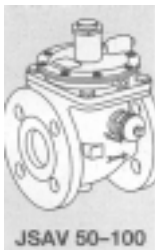

2 Затворете спирателният кран преди уреда.

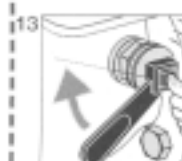
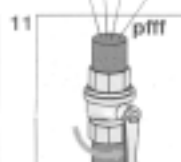
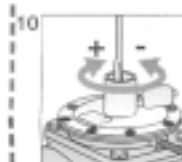
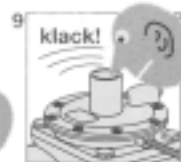
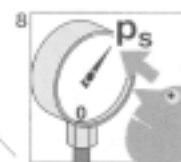
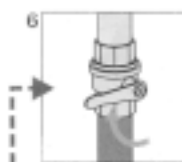
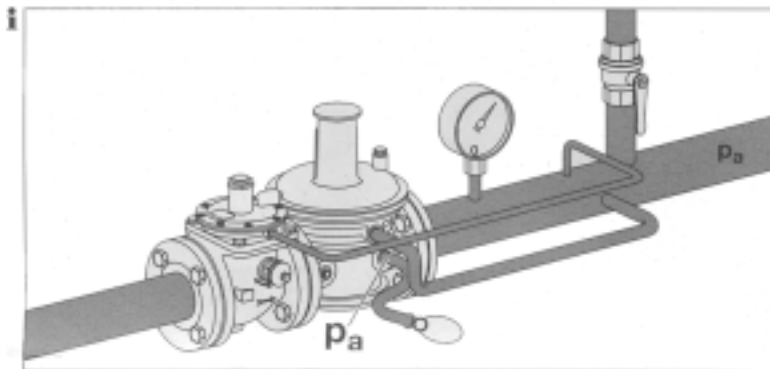
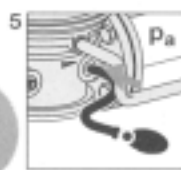
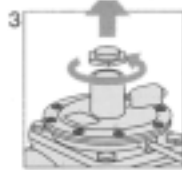
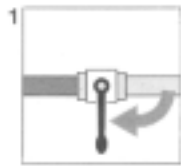

Препоръчва се ежегодна проверка на уредите. При работи с биогаз, проверка трябва се извършва на всеки 6 месеца.

Запазва се правото на технически изменения с цел усъвършенствуване на изделието!

Исклучителен представител за България:

**"Газтехника" ЕООД**

София 1606, бул. "Тотлебен" 63

тел.: 02-951-60-44;

факс: 02-951-60-55

